

# DEVELOPMENT OF BEAM POSITION MONITOR FOR A HEAVY-ION LINAC OF KHIMA

Ji-Gwang Hwang \*, Tae-Keun Yang, Ga Ram Hahn  
 Korea Institute of Radiological and Medical Sciences, Seoul, Korea

## Abstract

The carbon and proton beams are produced by the electron cyclotron resonance ion source with the energy of 8 keV/u and it is accelerated up to 7 MeV/u by the RFQ and IH-DTL. The accelerated beam is injected on the synchrotron through the medium energy beam transport (MEBT). In the MEBT line of KHIMA, the stripline beam position monitor (BPM) is installed to measure the beam trajectory and orbit jitter before the beam injection at the synchrotron. It is also used to measure the phase information such as a bunch length for the de-buncher tuning in MEBT line. The BPM has the position resolution of 100 μm with the diameter of 40 mm. The design study is performed and it is fabricated. In order to confirm the performance of the beam position monitor, the measurement of position accuracy and calibration by using wire test-bench, and the beam test with proton beam from MC-50 in KIRAMS are performed.

## INTRODUCTION

The Korea Heavy Ion Medical Accelerator(KHIMA) project was launched to establish a high energy heavy-ion particle based cancer therapy technique in Korea and to perform the patient treatment using a proton and carbon beams. The accelerator part consist of the low energy beam transport (LEBT) line, radio frequency quadrupole (RFQ) accelerator, interdigital H-mode (IH) drift-tube linac (DTL), medium energy beam transport line, synchrotron, and high energy beam transport line [1]. The KHIMA project, a proton and carbon therapy accelerator based on synchrotron, is currently under construction phase. It can provide a low intensity proton and carbon beams with an energy in the range of 110 to 430 MeV/u for carbon beam and in the range of 60 to 230 MeV for proton which corresponds to the water equilibrium beam range of 3.0 to 27.0 g/cm<sup>2</sup> [2, 3]. In the medium energy beam transport (MEBT) line of the KHIMA project, it has two phase probes, profile monitor, and the beam position monitor to verify the beam quality from the linear accelerator which consists of the RFQ accelerator and IH-DTL. The phase probe which is installed at the exit of the linear accelerator is used to optimize the amplitude and phase of the linear accelerator by measuring the longitudinal particle distribution and energy of beam. By using two phase probes which is installed at the upstream and down stream of the charge stripper, the statues of the stripper is monitored. The grid-wire profile monitors are installed to measure the beam

profile and orbit simultaneously. In order to measure the orbit jitter at the injection position of the ring and the longitudinal distribution for the tuning of the de-buncher, the beam position monitor is adopted at the entrance of the synchrotron. The schematic layout and position of the diagnostics in the MEBT line is shown in Fig. 1.

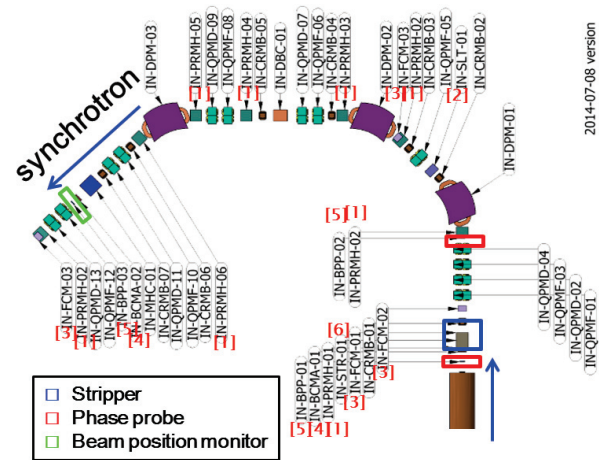

Figure 1: Schematic layout and position of diagnostics in MEBT line.

## STRIPLINE BEAM POSITION MONITOR DESIGN

The beam position monitor which has the position resolution of 100 μm is required to match and control the beam trajectory for the high beam injection efficiency into the synchrotron. Since the beam position monitor is also used to measure the longitudinal distribution of the beam from heavy-ion linac, the frequency response of the beam position monitor is significant. In order to determine the type of the beam position monitor between the capacitive and stripline type, the transfer impedance, which is directly proportional to the signal strength from the device, as a function of the frequency was calculated. The pulse duration and peak current of the beam in the MEBT line after the charge stripper are about 30 μs and ~ 0.2 eA, respectively. The calculation result is shown in Fig. 2.

\* hwang@kirams.re.kr

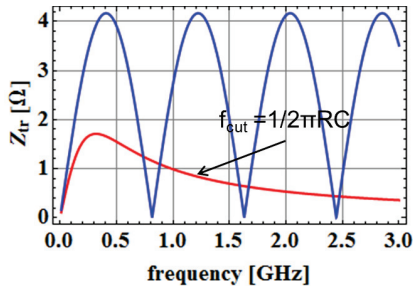

Figure 2: Transfer impedance of capacitive (red) and stripline (blue) as a function of frequency.

The transfer impedance of the stripline beam position monitor at the frequency of 200 MHz is higher than the capacitive beam position monitor. Especially, the transfer impedance at frequency of 2 GHz which is required for measuring the longitudinal distribution is also higher. In order to reduce the number of the signal port, the stripline beam position monitor with a shorted end is adopted. The detail structure and equilibrium circuit for the stripline beam position monitor are shown in Fig. 3.

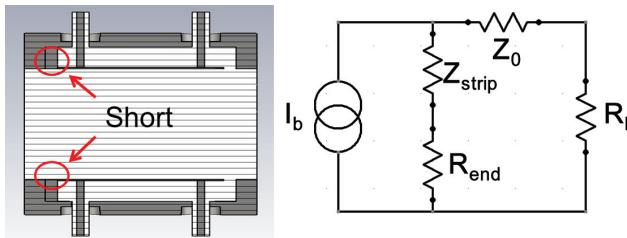

Figure 3: Detail structure (left) and equilibrium circuit (right) for stripline beam position monitor.

The length and coverage angle of the stripline are optimized to obtain the higher signal for the beam current of 0.2 mA. The length of the stripline is to be 40 mm. In order to verify the frequency response of the stripline beam position monitor, the S-parameter between four ports is calculated that is shown in Fig. 4 [4].

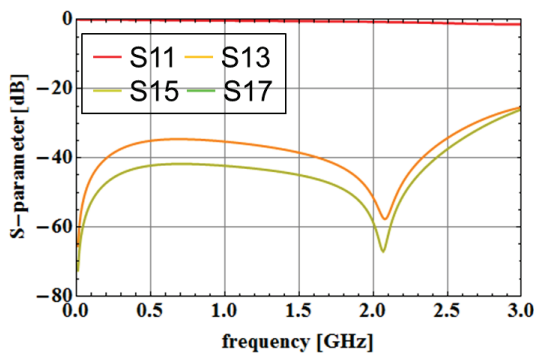

Figure 4: Frequency specification (S-parameter) of designed stripline beam position monitor.

The cross-talk between two electrodes is smaller than the

-30 dB which is enough to achieve the position resolution of 100 μm.

### BEAM TEST USING PROTON BEAM

The beam test using proton beam with the energy of 30 MeV ( $\beta = 0.2$ ) and beam current of a few μA is performed in the MC-50 cyclotron at KIRAMS. The wide-band pre-amplifier with the bandwidth of 0.125 ~ 1.61 GHz was used [5]. The maximum gain of the pre-amplifier is to be 60 dB with 20 dB gain step, minimum gain of 0 dB, and the input power of -50 to 0 dBm. It was developed by the KIRAMS. The collimator is installed in the experiment because the beam size is larger than the diameter of the stripline BPM in the MC-50. The photograph of the beam test line is shown in Fig. 5.

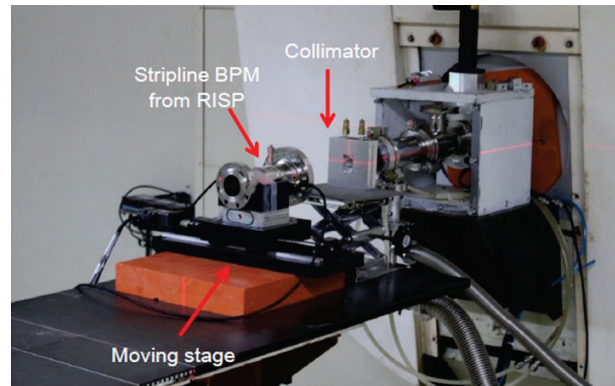

Figure 5: Photograph of beam test in MC-50 cyclotron at KIRAMS.

The stripline beam position monitor was installed on the movable stage for varying the relative position and the left and right electrodes are connected on the pre-amplifier. The gain of the pre-amplifier is adjustable via the Ethernet connection. The schematic drawing of the test set-up is shown in Fig. 6.

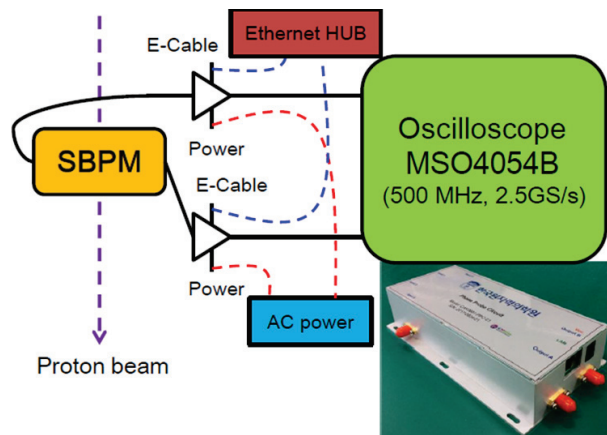

Figure 6: Schematic drawing of test set-up.

The gain of the pre-amplifier is set to 60 dB and the data was obtained by using digital oscilloscope, MSO 4054B.

The measured signal from the left and right electrodes with the gating time of  $2\mu\text{s}$  is shown in Fig. 7.

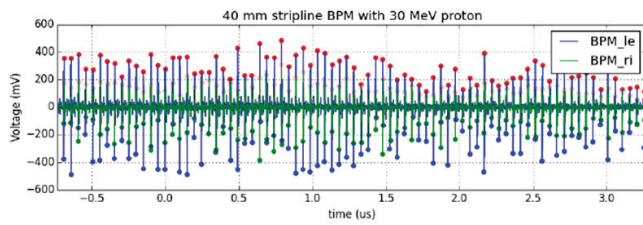

Figure 7: Measured signal from left and right electrodes with gating time of  $2\mu\text{s}$ .

Due to the charge jitter for each bunches, the amplitude of the signal is fluctuated. In order to reduce the effects of the charge jitter, the amplitude of the each peak was determined by the fitting method. The formula which is used in the fitting method is given by Eq. 1.

$$V_{out}(t) = A \sin(2\pi f_0(t - \phi)) \Pi(f_0(t - \phi)), \quad (1)$$

where  $\Pi(t) = 1$  for  $|t| \leq \frac{1}{2}$  and 0 otherwise,  $f_0$  is the signal frequency,  $A$  is the amplitude of the signal, and  $\phi$  is the zero-crossing point of the signal. From the fitted value of the zero-crossing point, the repetition rate of the pulses calculated to calculate the frequency of the cyclotron. The resonance frequency of the cavity in the cyclotron is 20.28 MHz. It is shown in Fig. 8.

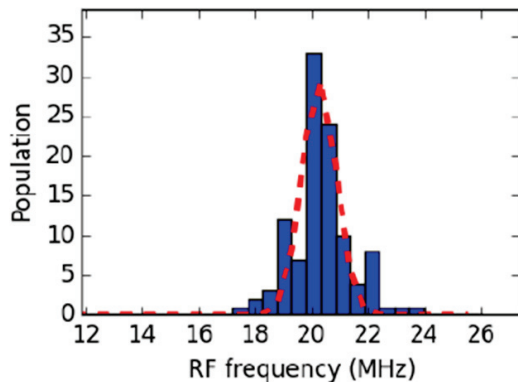

Figure 8: Comparison of measured results using wire test bench and proton beam.

The measured frequency from the repetition rate of the pulses is 20.4 MHz. The reciprocal of the repetition rate of the pulse,  $1/T_0$ , is well correspond to the RF frequency,  $f_{RF}$ , of the cavity in the cyclotron. The signal from the stripline beam position monitor was measured with the various offset for verifying the linear response region. The measured results using the wire test bench and proton beam were compared and it was shown in Fig. 9.

The measurement result using the proton beam agrees well with the linearity measurement on the wire-test bench.

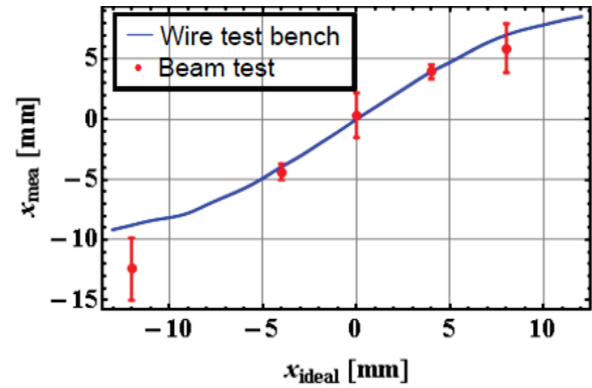

Figure 9: Comparison of measured results using wire test bench and proton beam.

The linear region is from -5 mm to 5 mm which is the 1/4 of the full aperture.

## ACKNOWLEDGEMENT

This work was supported by the National Research Foundation of Korea(NRF) grant funded by the Korea government(MSIP) (no. NRF-2014M2C3A1029534). And this experiment was conducted at the MC50 cyclotron facility operated by KIRAMS supported by the National R&D Program through the Korea Institute of Radiological and Medical Sciences funded by the Ministry of Science, ICT & Future Planning. (No.1711021909).

## CONCLUSION

By the comparison between capacitive type and stripline type beam position monitor, which will be installed in the medium energy beam transport line of KHIMA, the stripline beam position monitor is adopted to measure the beam position and longitudinal distribution simultaneously. The electromagnetic design of the stripline beam position monitor was performed to achieve the position resolution of 100  $\mu\text{m}$ . The beam test was performed using proton beam from the MC-50 cyclotron in KIRAMS. Based on the test result, the performance of the position monitor agrees well with the designed parameter.

## REFERENCES

- [1] Geun-Beom Kim *et al.*, in *Korea Heavy Ion Medical Accelerator Project*, FRXAA01, these proceedings, IPAC16, Busan, Rep. of Korea (2016).
- [2] <http://www.kirams.re.kr/eng/khima>.
- [3] Chawon Park *et al.*, in *The 18th International Conference on Accelerators and Beam Utilization (ICABU2014)*, Daejeon, Korea (2014).
- [4] CST-MWS and PS website : <https://www.cst.com/>.
- [5] Ji-Gwang Hwang *et al.*, *Proceedings of IBIC2015*, MOPB037, Melbourne, Australia (2015).