

DE LA RECHERCHE À L'INDUSTRIE



Alexis Gaget, Tom Joannem

CEA Saclay Irfu DIS, France

www.cea.fr

THE CONTROL SYSTEM OF THE ELLIPTICAL CAVITY AND CRYOMODULE TEST STAND DEMONSTRATOR FOR ESS

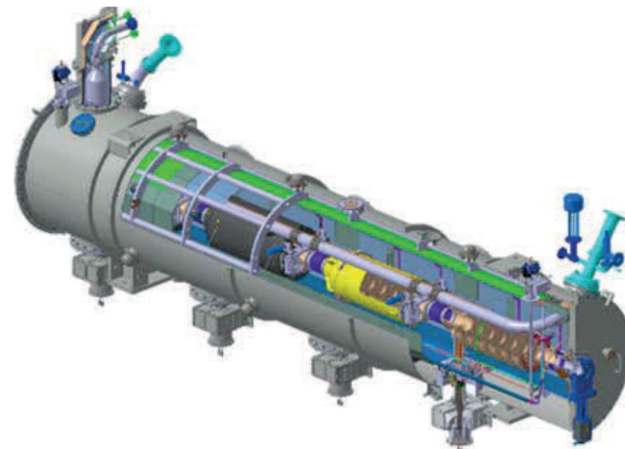

ICALEPCS October 10th 2019



ESS (European Spallation Source):

- European collaboration

The European Spallation Source (ESS) is a European Research Infrastructure Consortium (ERIC), a multi-disciplinary research facility based on the world's most powerful neutron source



CEA IRFU Involved in the control system of the following systems :

- Source and LEBT
- RFQ (couplers conditioning, cooling system, vacuum)
- Diagnostics nBLM (MOMPL008)
- Elliptical cavities and cryomodule

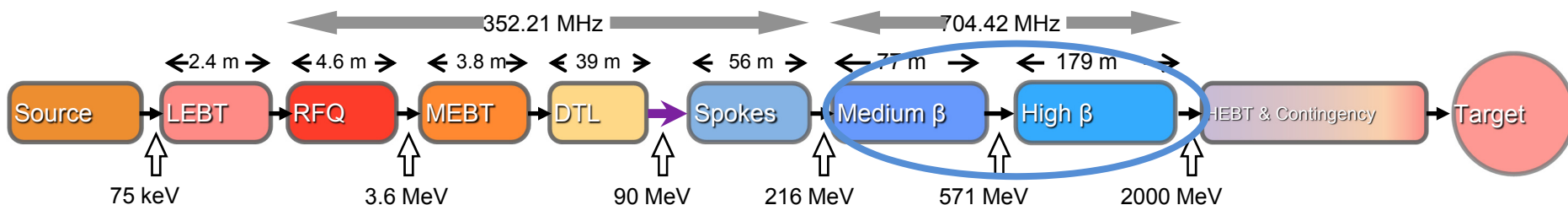

Cryogenic

- Automatic sequences for cooling down
- Nitrogen and helium tanks management

Vacuum

- Isolation and beam vacuum control

Cavities tuning

- Controlling Phytron motors for slow motion
- ETS200S technology
- Controlling Piezoelectric motor for fast motion
- Automatic sequences for cavities characterization

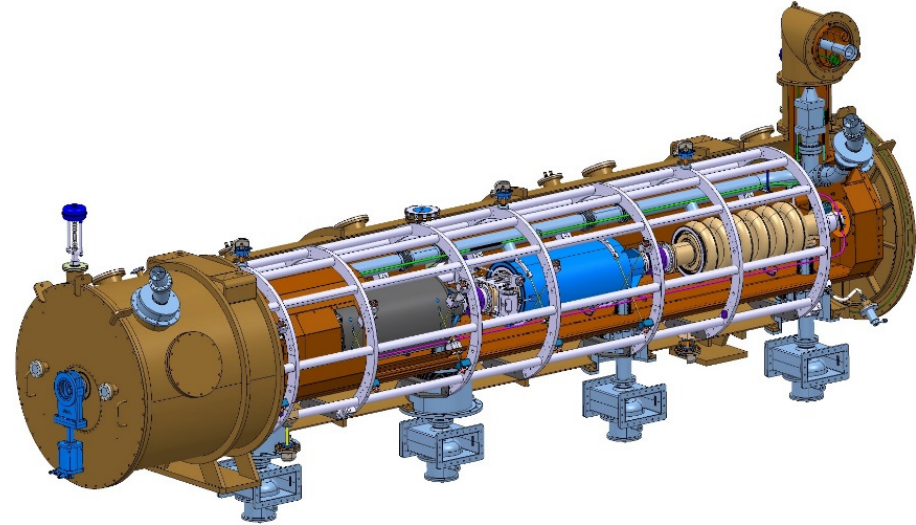

Warm and cold conditioning

- RF signal measurement
- PM / PUE- measurement
- Automatic sequences for coupler conditioning

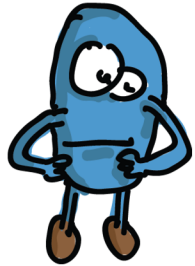

SIEMENS

PLC

EPICS

The EPICS logo features the word "EPICS" in a bold, dark blue, sans-serif font. Below it is a graphic element consisting of three vertical bars of varying heights, also in dark blue.

Fast Acquisition

loxos IFC1210 VME Card

- CPU
- VME 64x
- 2 mezzanine card slots
- Realtime Linux

loxos ADC3111

- Mezzanine card
- Up to 250MSamples/s
- 8 channels
- +/- 0,5V

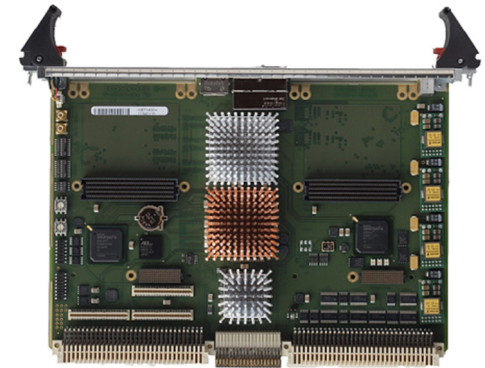

Remote I/O

Beckoff EtherCAT Modules

- Wide variety (0-10V, 4-20mA, PT100 ...)



Timing system

MRF EVG/EVR 230

- Optical fiber
- EPICS driver

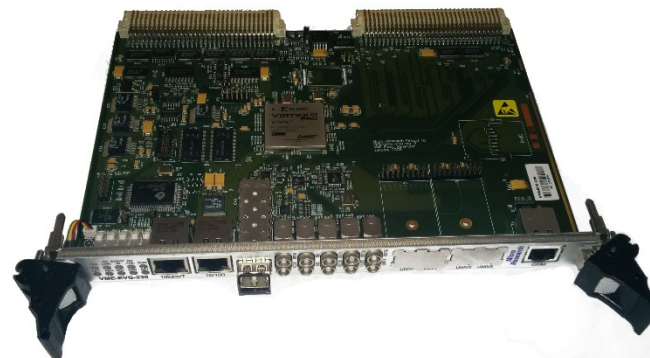

Siemens PLC 1500 generation

- Made for control automatic process
- Fieldbus ready: Profinet, Profibus, TCP-IP, Modbus
- Wide variety (0-10V, 4-20mA, PT100 ...)
- EPICS drivers : S7PLC (Rd) / Modbus (Wr)



Laboratory standards

- Standard hardware and software solutions
- Standard code writing rules
- Standard naming convention
- Quality process

PID	Channels fail	EPICS
PT100	Flow meter	Vacuum gauges
Analog valve	Motor control	Pumps control

Cryogenic

- Automatic sequences for cooling down
- Nitrogen and helium tanks management

Vacuum

- Isolation and beam vacuum control

Cavities tuning

- Controlling Phytron motors for slow motion
- ETS200S technology
- Controlling Piezoelectric motor for fast motion
- Automatic sequences for cavities characterization

Warm and cold coupler conditioning

- RF signal measurement
- PM / PUE- measurement
- Automatic sequences for couplers conditioning

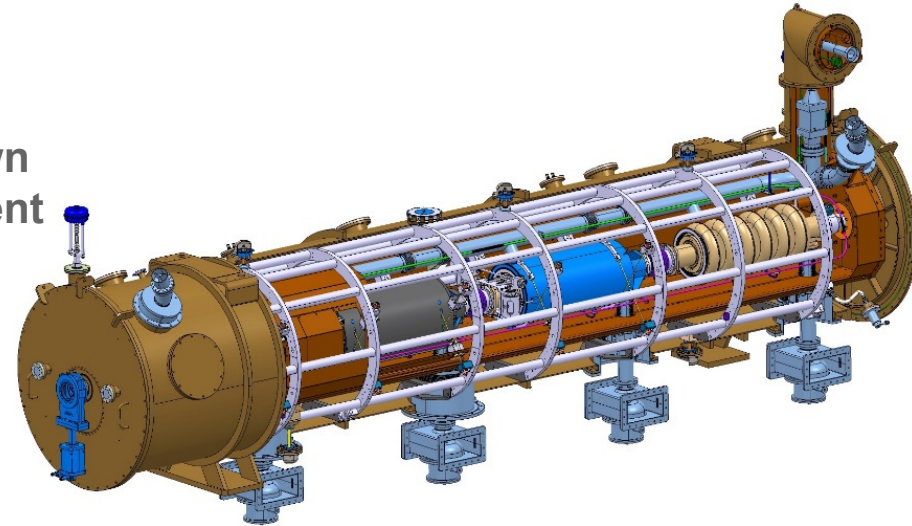

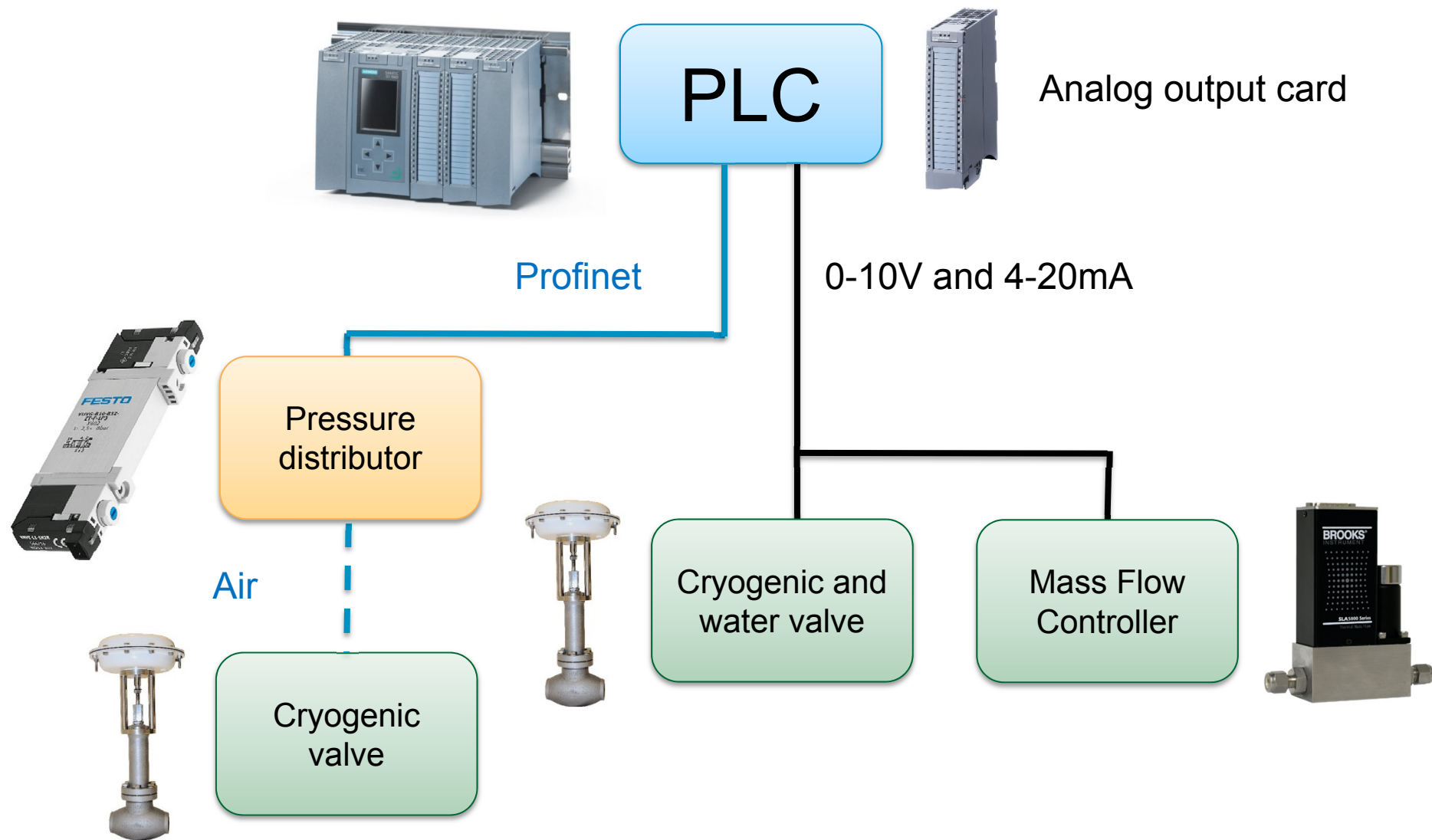

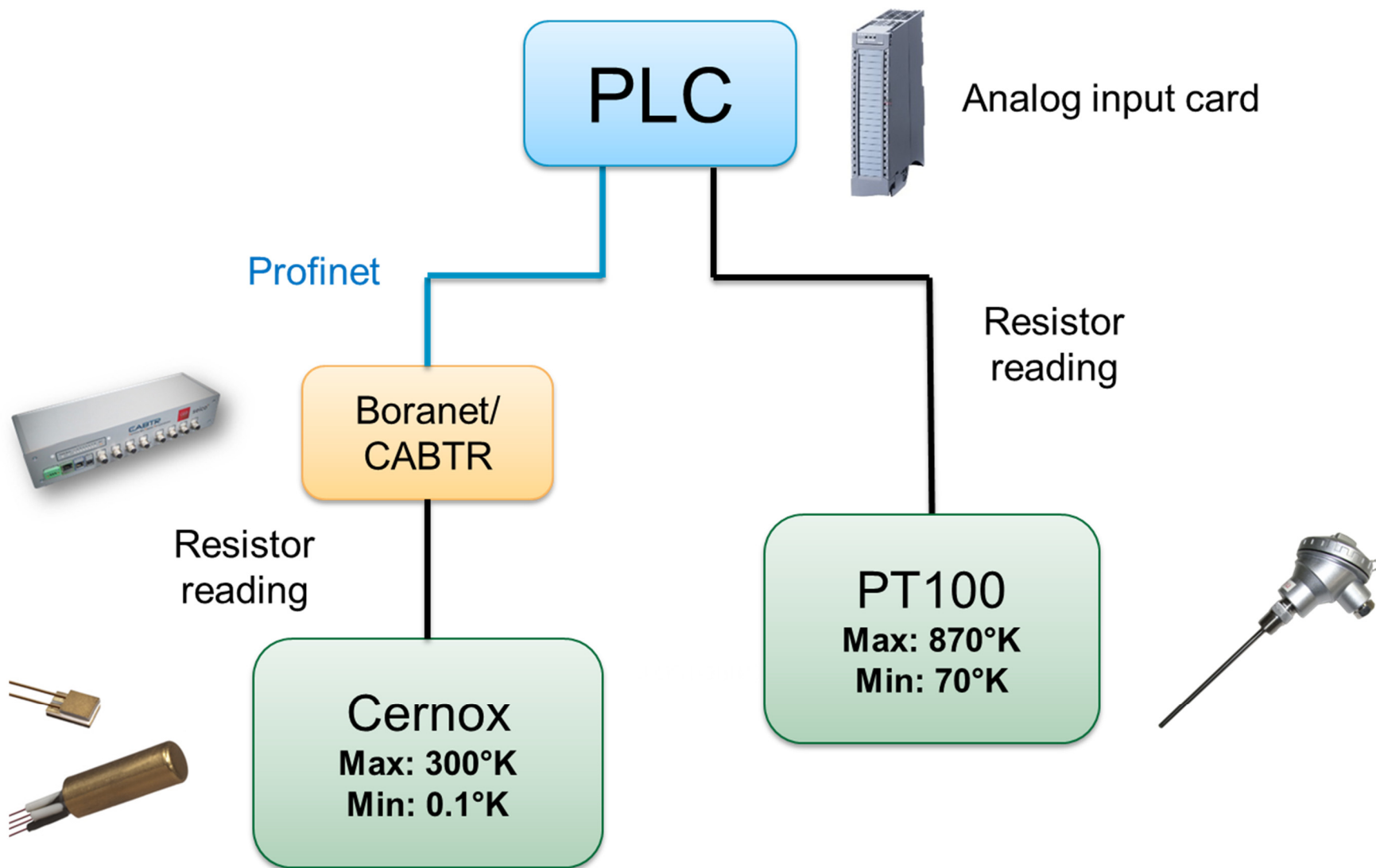

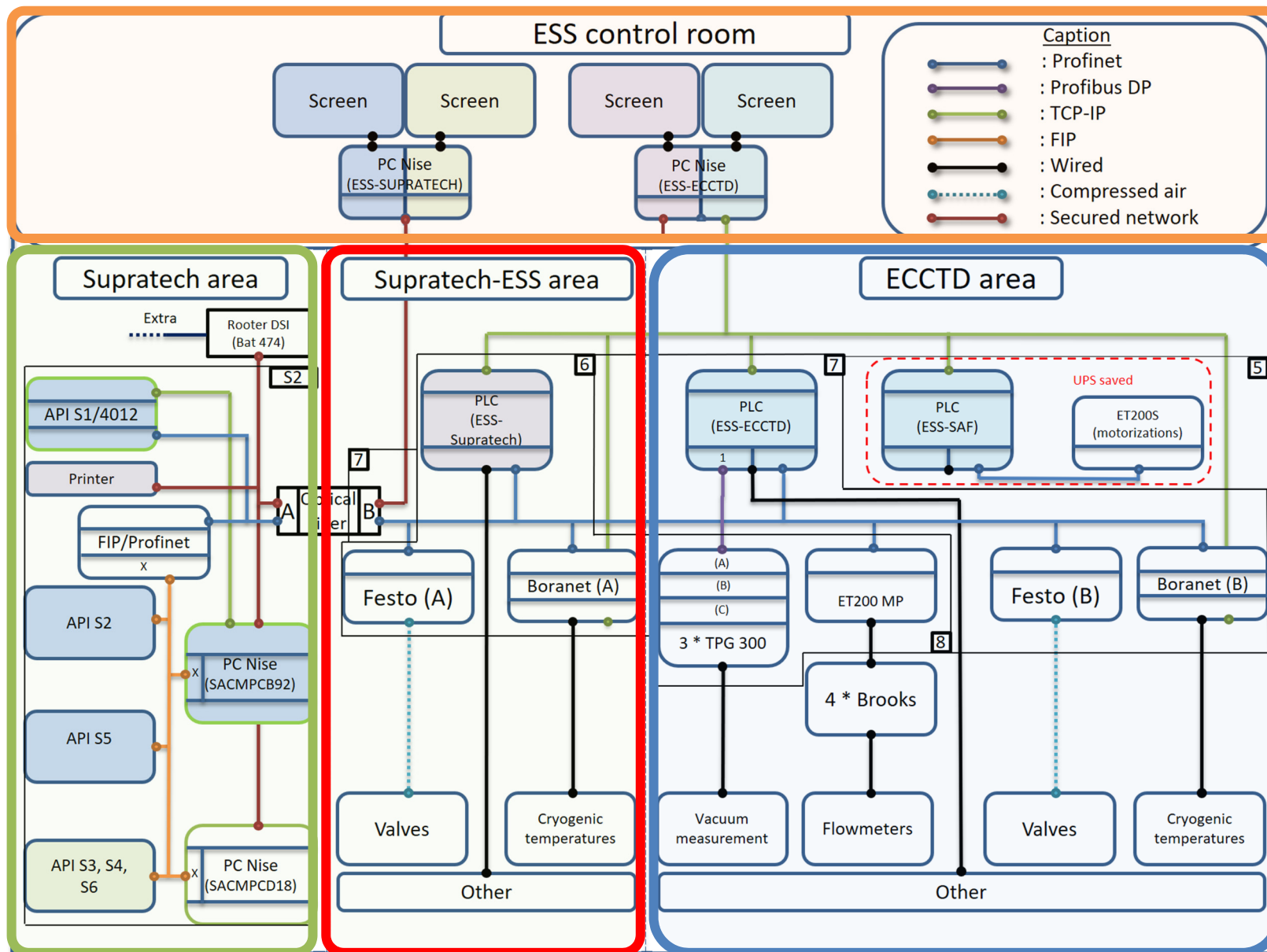

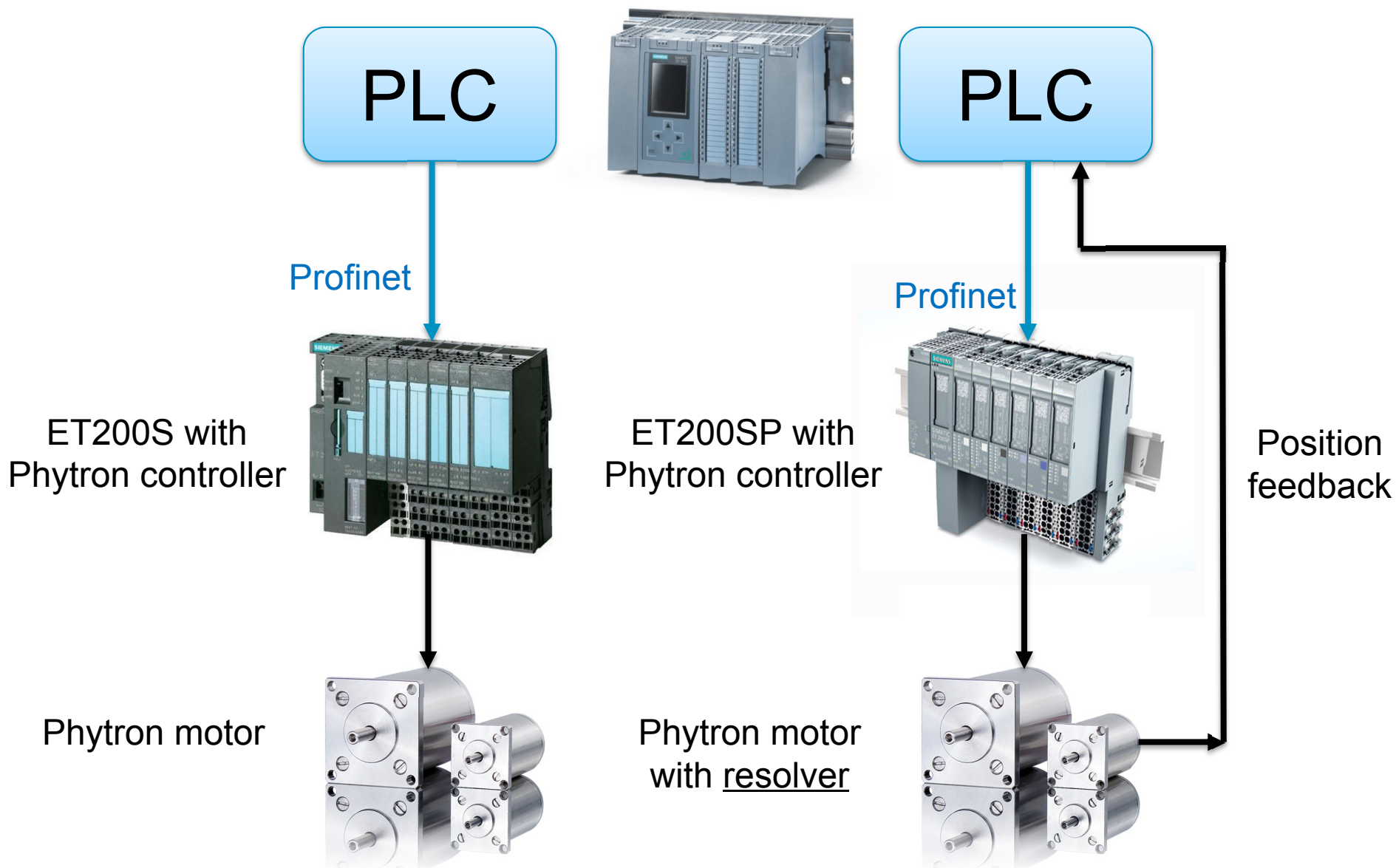

Cryogenic

- Automatic sequences for cooling down
- Nitrogen and helium tanks management

Vacuum

- Isolation and beam vacuum control

Cavities tuning

- Controlling Phytron motors for slow motion
- ETS200S technology
- **Controlling Piezoelectric motor for fast motion**
- **Automatic sequences for cavities characterization**

Warm and cold coupler conditioning

- RF signal measurement
- PM / PUE- measurement
- **Automatic sequences for couplers conditioning**

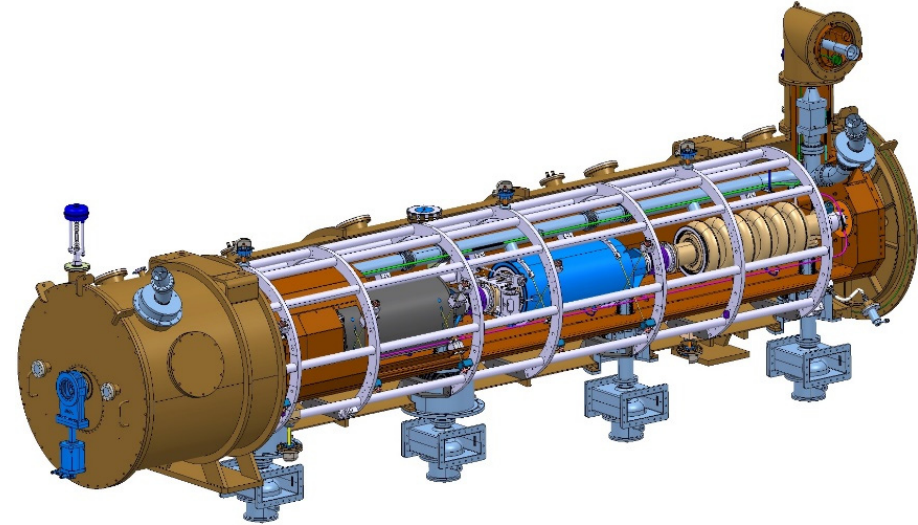

EPICS

streamDevice

MRF
Timing System

trigger

Function Generator
Agilent AFG3252C

Piezo Driver
Noliac NDR6220

Piezo

M

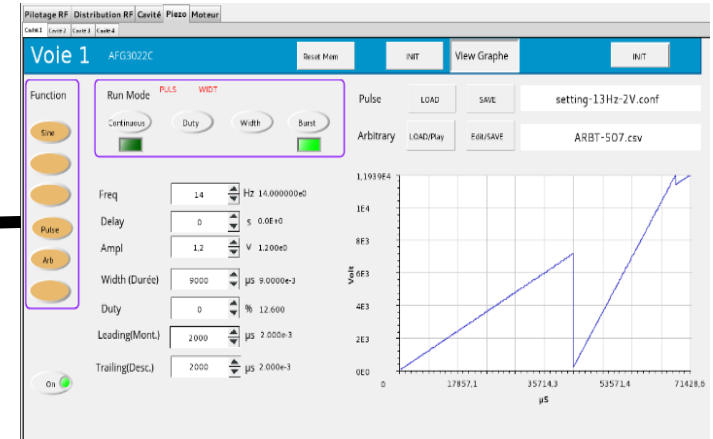
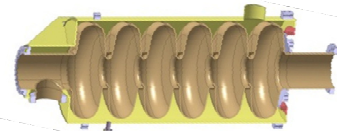

Automatic cavities characterization

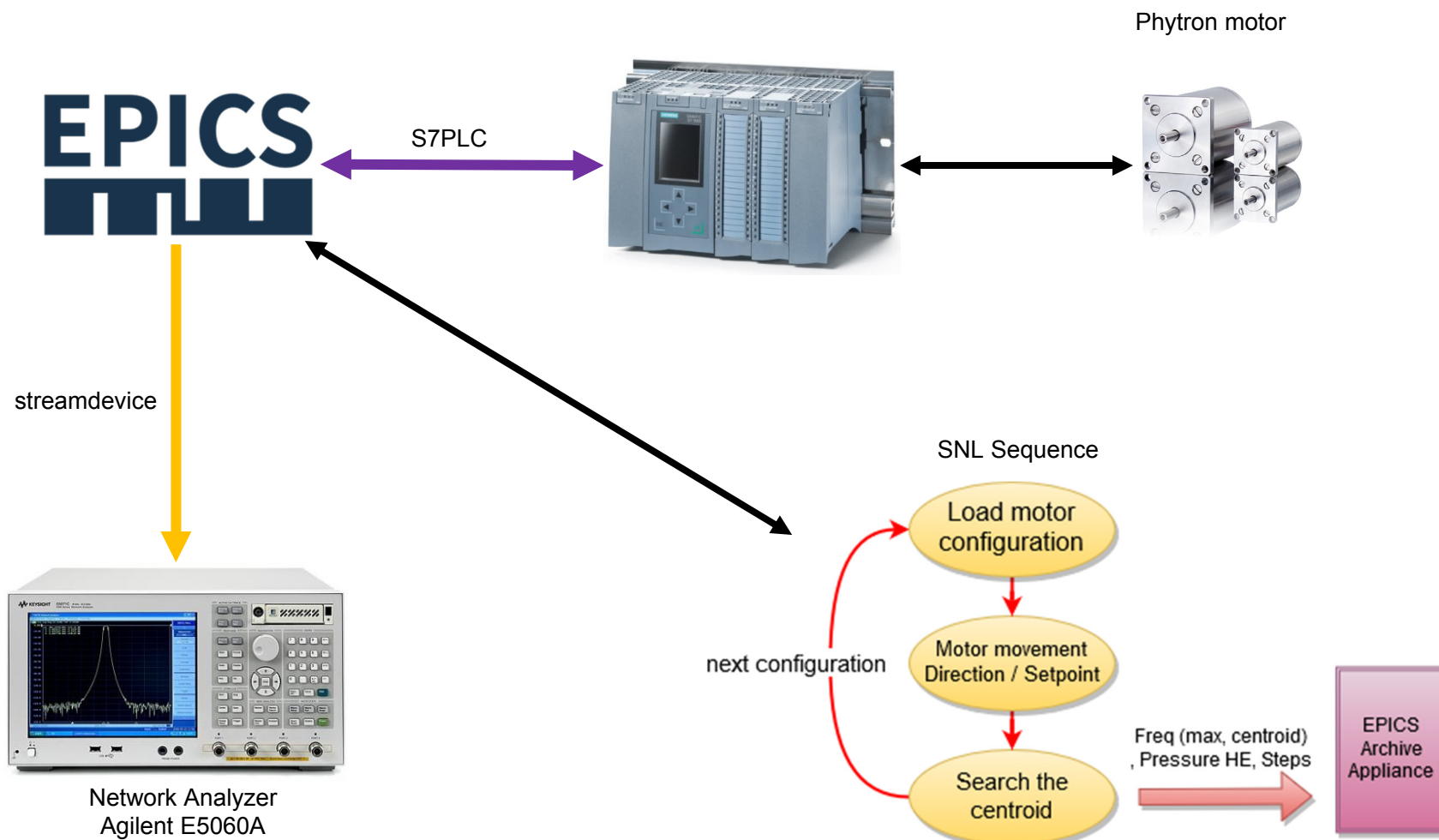

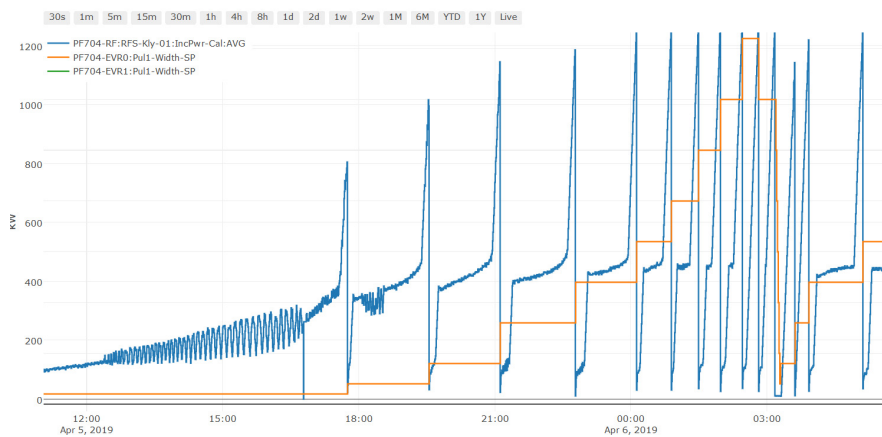
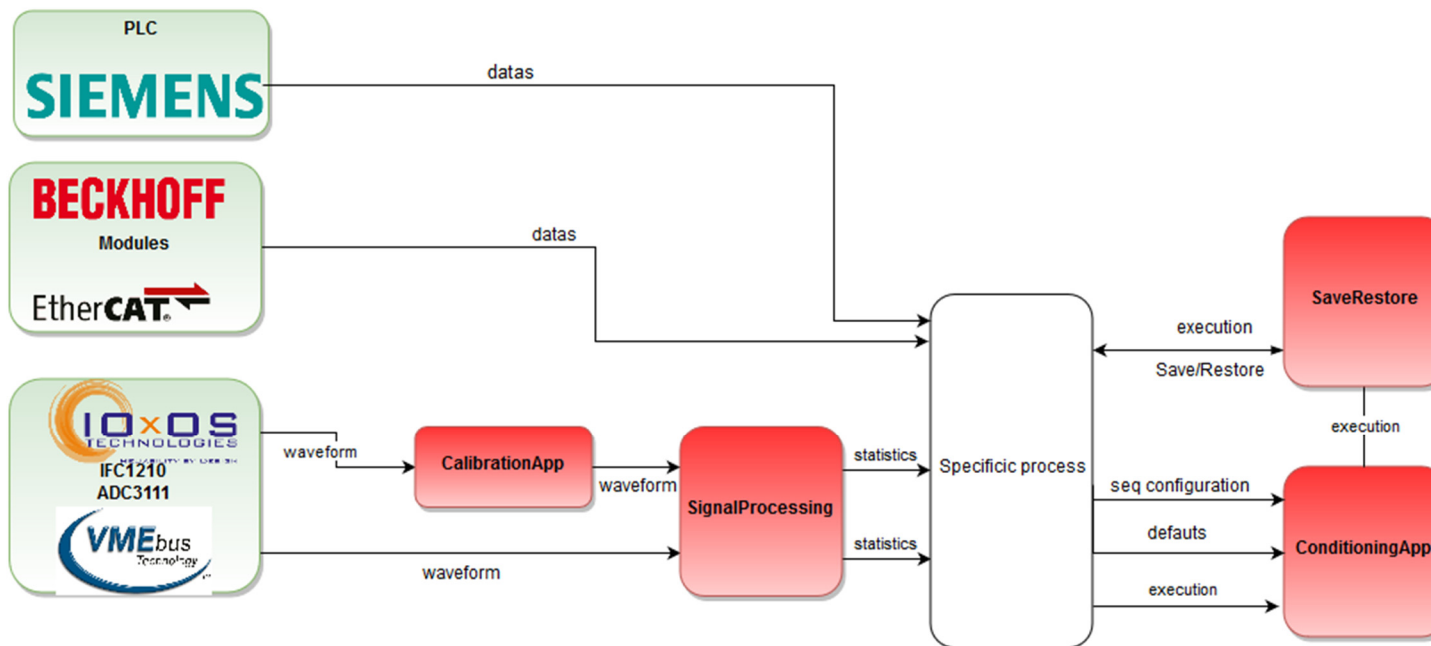

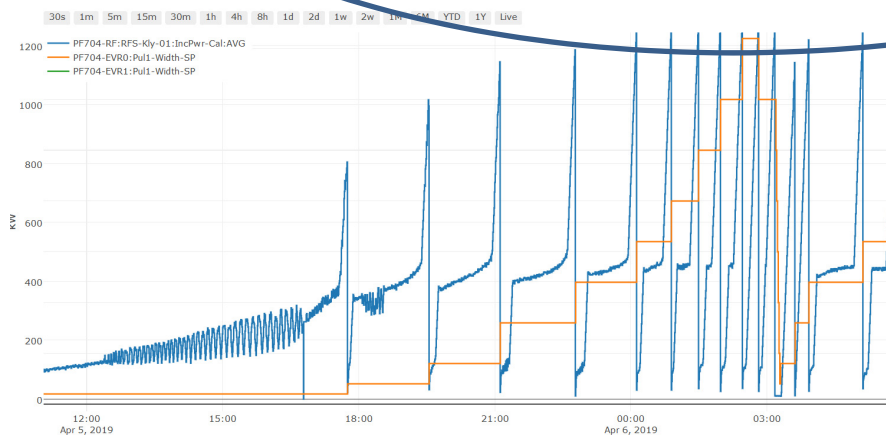
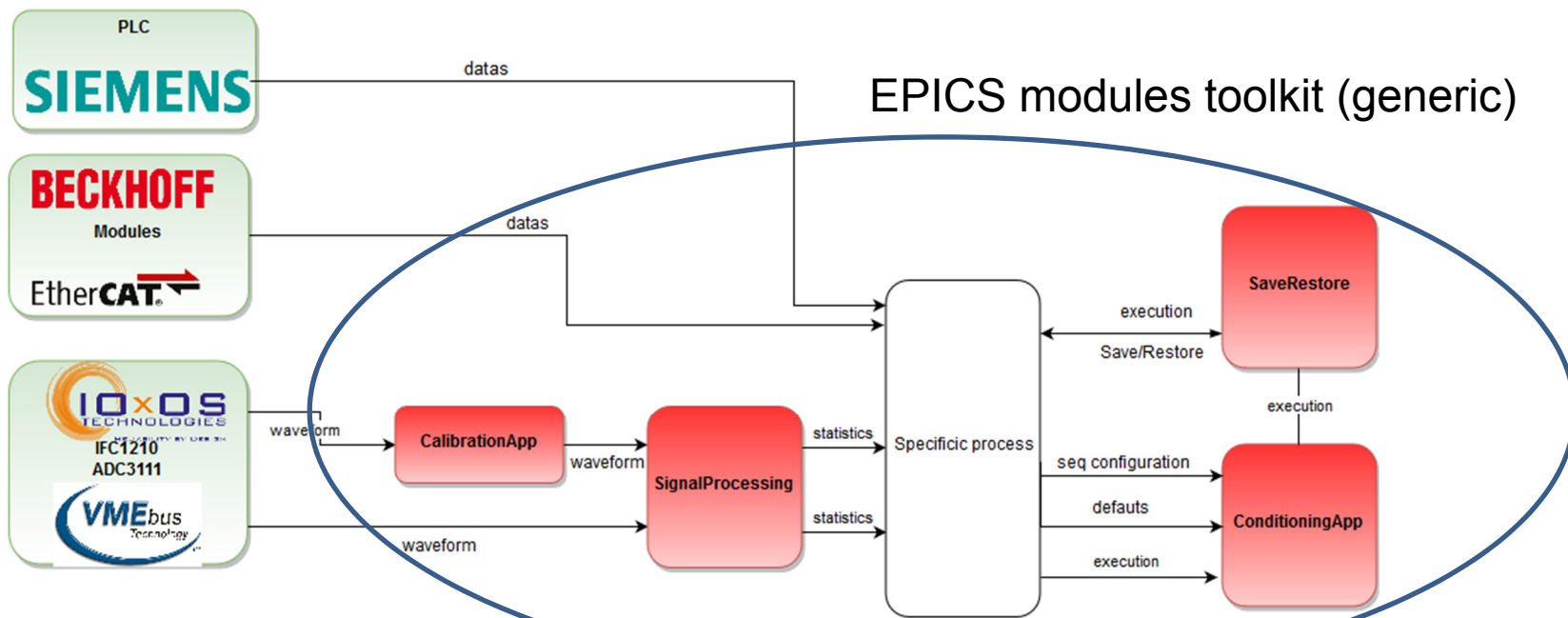

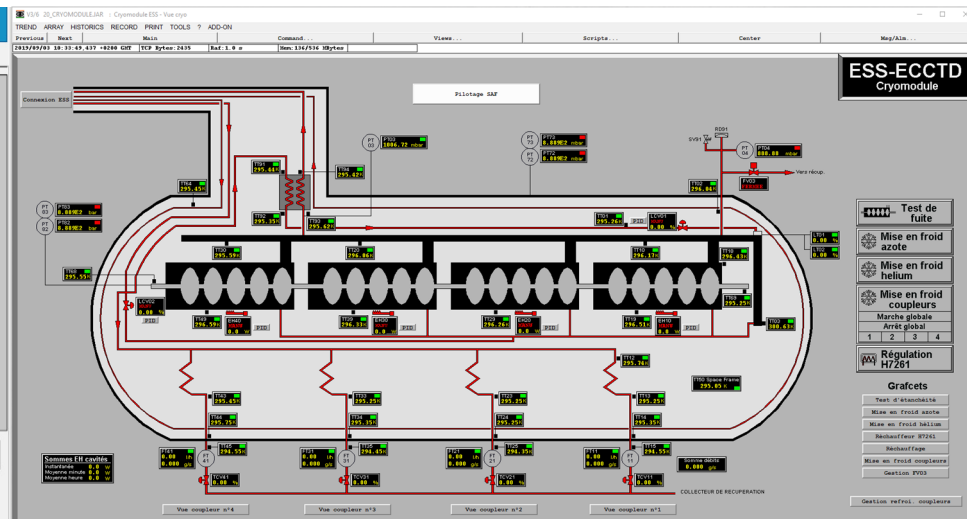
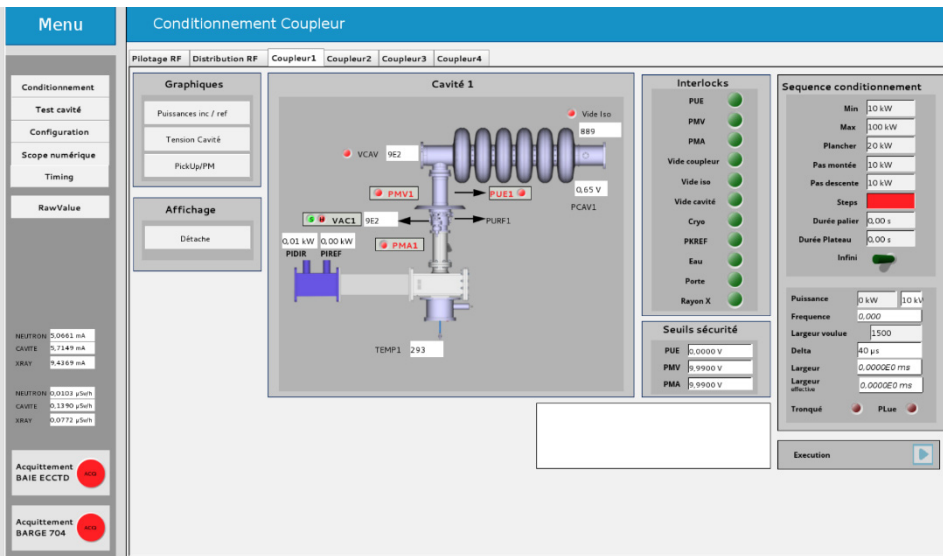

- Cryomodule control system working and in use
- Technology knowledge improvement
- Ready for next cryomodules

Acknowledgments :

Q. Bertrand, A. Gomes
J.F. Lecoite, D. Loiseau
Y. Mariette

alexis.gaget@cea.fr
tom.joannem@cea.fr
Paper : THAPPO2

Thanks for
your attention

Questions ?

